

COMPACT EXCAVATOR
R35Z-9A

Operating weight: 3690 kg / 3550 kg
Engine power: 18.2 kW (24.4 HP) / 2200 rpm
Bucket capacity: 0.09 m³



Walk-around

R35Z-9A

Productivity & Efficiency

- Powerful & fuel efficient Yanmar engine
- Advanced hydraulic system
- Variable swing boom
- Engine auto-idling system
- Angle dozer blade

OPTION



Safety

- Sturdy structure
- ROPS/TOPS/FOPS cabin
- 360° view from cabin
- Extra counterweight for increased stability
- Safety valves on arm, boom and blade cylinders
- Anti-theft device

Operator comfort

- Spacious cabin with 360° view
- Adjustable suspension seat
- Colour display
- Adjustable wrist rests
- Ergonomic joystick handling
- Audio system with USB and MP3 radio
- Practical storage compartments
- Heating and air conditioning
- Upper roof window
- Sliding fold-in front window
- Easy-access tiltable arm console

Serviceability & Durability

- Easy access to components
- Wide open engine hood
- Central greasing system
- Centralised grease points
- Counterweight rear guards
- Long life shims, bushings and hydraulic oil

OPTION

Productivity & Efficiency

SMOOTH AND EFFICIENT TO BOOST YOUR PRODUCTIVITY

The R35Z-9A is equipped with a quiet, eco-friendly and yet high-performing Yanmar engine. Its short tail swing radius allows the operator work in confined areas like close to buildings on roadways, and in urban areas. This compact radius design provides easy and efficient operation in any limited space work environment.



Tail swing radius:
870 mm

Zero tail swing
The R35Z-9A's short tail swing radius provides easy and efficient operation in any limited space work environment.

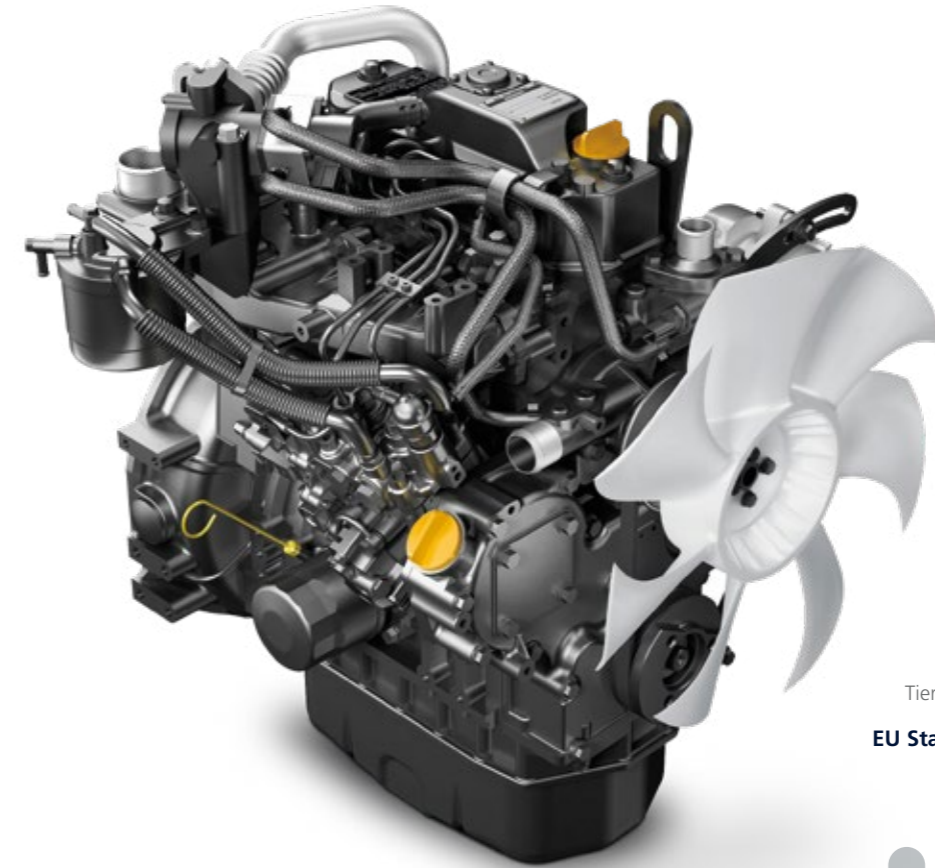

Tier4 Final(2014)
EU Stage-V(2019)

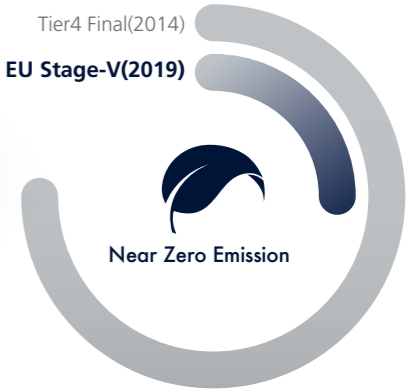

Near Zero Emission

Engine

The Yanmar 3TNV88F engine represents the most compact multi-cylinder liquid cooled industrial diesel engine providing smooth, powerful operation, while ensuring compliance with the strict European Stage V emission regulations without additional after-treatment tools. This high-performing engine provides enhanced reliability and simplified maintenance. The half-float valve cover and Mo52 coated piston are in addition reducing the noise levels and vibration.



Advanced hydraulic system

To achieve optimum precision, the hydraulic system provides the operator with super fine touch and easy controllability.



Auto-idle function

The auto-idle function, which comes as standard on the R35Z-9A, improves fuel efficiency by reducing engine speed automatically when the operator is not using the control levers.



4-way angle dozer blade

As an option the R35Z-9A Mini Excavator can be equipped with a 4-way angle dozer blade. The angle blade provides a great solution for grading material, backfilling of trenches or snow removal. The blade angle is easily adjusted from the cabin, allowing for swift and precise operation. Levelling has never been so easy.

Operator comfort

COMFORT AND CONVENIENCE DESIGNED AROUND YOU

The R35Z-9A cabin was designed to offer every operator a productive and stress-free working environment. Its ergonomic design will help you perform easier and with lower fatigue. Control levers are easily accessible and an instrument display is provided to keep the operator informed of relevant machine information.

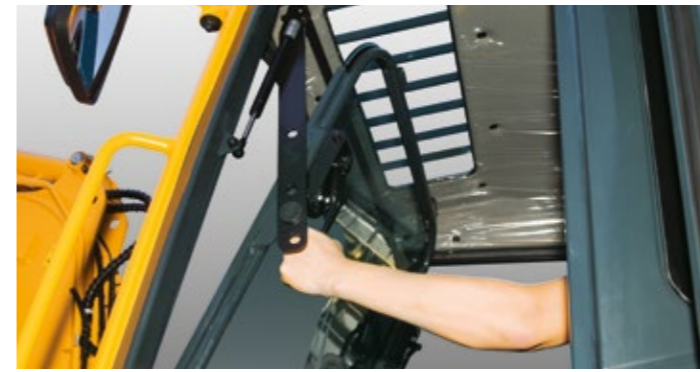
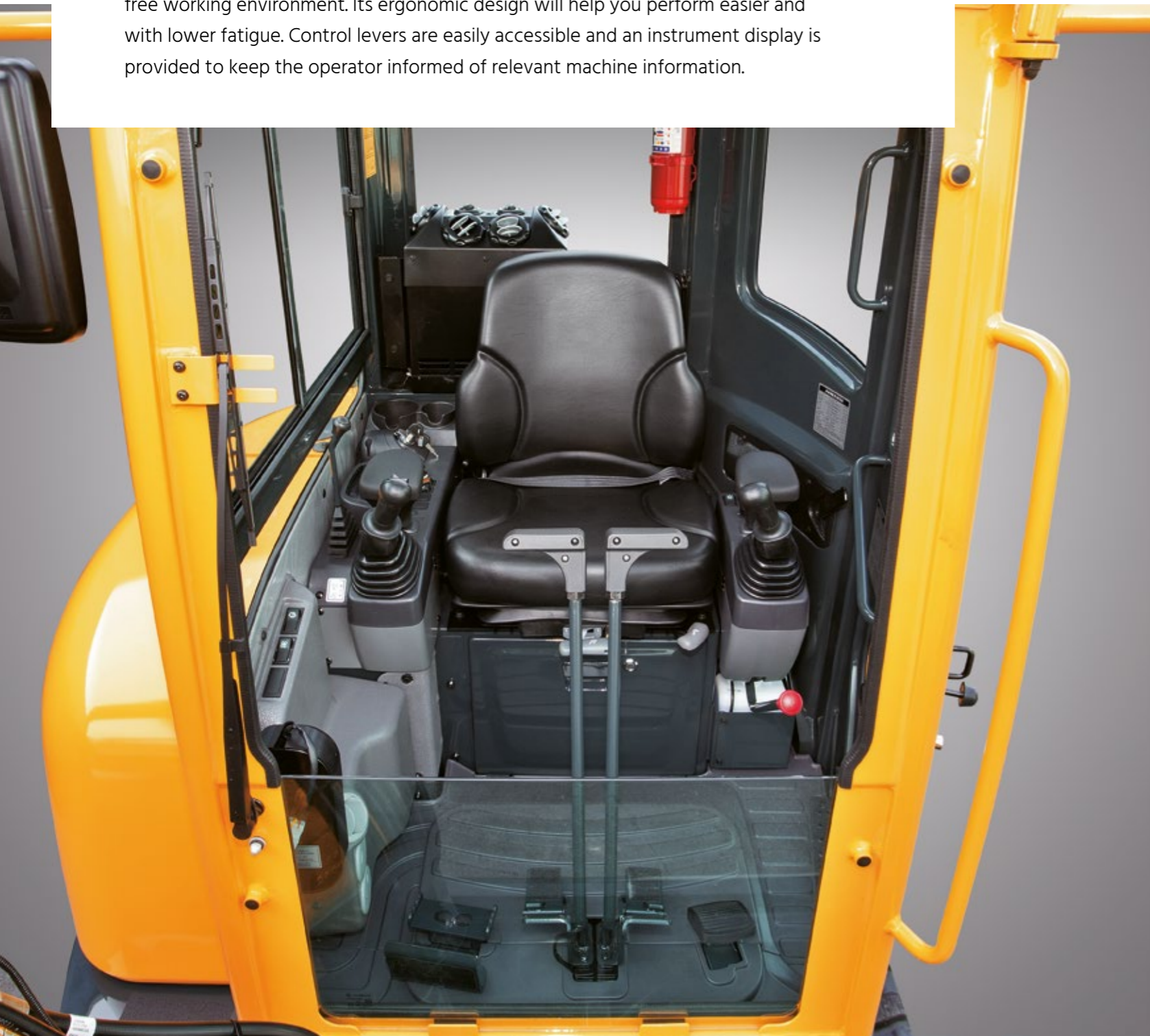

Sliding front window

A sliding fold-in front window is easily opened and safely stored in an open position to improve ventilation and visibility (cabin type only).



Monitor

The monitoring system of the R35Z-9A provides the operator with machine status information, including: engine oil pressure lamp, battery charge lamp, engine coolant temperature and a fuel gauge.



Pedals

All pedals are foldable for additional floor space. Footrest, attachment pedal, left and right travel pedals and boom swing pedal are arranged for convenient access.



Seat

In a 9A series cabin, you can easily adjust the seat and wrist rests settings to best suit your preferred operating condition. The left and right control levers are ergonomically located for convenient access. A safety lock system is designed to prevent exiting the cabin while hydraulic controls are live. When the safety lever and left side console are positioned upright, hydraulic functions are disengaged.

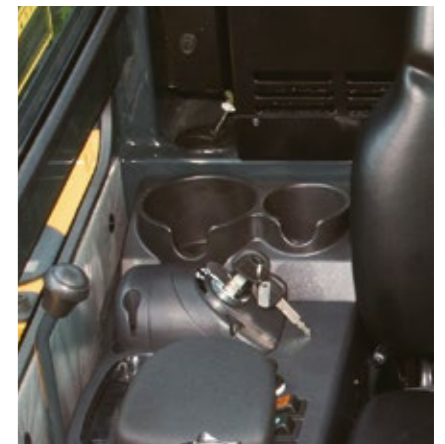

Storage compartments

Two cup holders are integrated into the right console for large and small drink storage. An additional storage box with key lock is accessible under the operator's seat.

Proportional Auxiliary Hydraulic System

- Proportional Control Switch for better speed control (OPTION)
- Enlarge the Operation Convenience

Tiltable left-side console

A tilt-up left side control console provides easier entrance and exit from the cab.



Safety

EXTRA PROTECTION FOR YOU AND YOUR MACHINE

Small details make a big difference when it comes to safety. We designed the R35-9A to offer maximum protection for you, your worksite and your investment without compromising on productivity.



“The clear view from the cabin really helps when I’m working on busy sites and zero tail swing gives me extra confidence when I’m working in tight spaces.”

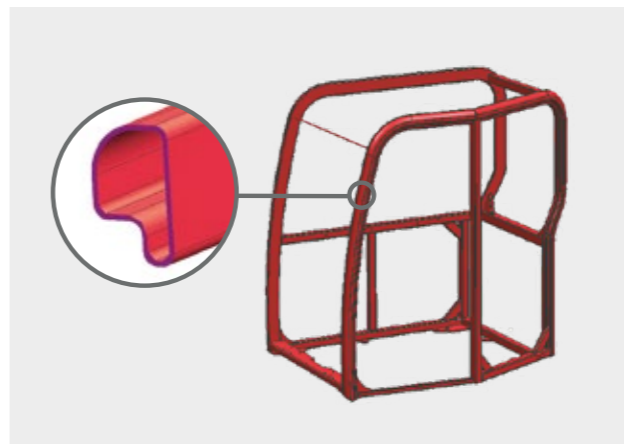

◀ **Cabin structure**

The cabin structure is strong, sturdy and certified to ISO 12117-2 ROPS (Roll-Over Protective Structures), ISO 12117 TOPS (Tip-Over Protective Structures) and ISO 10262 FOPS (Falling Object Protective Structures) safety standards, ensuring more safety and improved visibility. Structural integrity has been tested using FEM (Finite Elements Method) analysis and long-term durability tests.



◀ **Excellent visibility**

The cabin was designed for more space, a wider field of view and operator comfort. Special attention was given to creating a clear, open and convenient interior with ample visibility of the machine surroundings and the job at hand. Every element is precisely balanced to place the operator in the perfect position to work safely and securely.



◀ **Cylinder protection**

Added protection is ensured by standard steel plate covers on boom and dozer blade cylinders. They protect the cylinder rod and housing from damages through obstacles or falling debris. The protection plates extend the lifetime of components and reduce cost of maintenance.



Serviceability & Durability

MAXIMUM UPTIME TO PROTECT YOUR BUSINESS

The peace of mind that comes with quick, low-effort servicing is also part of the Hyundai Effect. The R35Z-9A is designed for fast, easy maintenance and repairs with convenient access to important servicing points. The engine hood opens wide to provide easy access for cleaning and routine tasks. All components and materials have been optimised to ensure a long, trouble-free life.



Easy access

All R35Z-9A doors, covers and hoods were built for complete open access, making regular service and maintenance easy and convenient.



Auto shift down system

When working under heavy load or when the machine is climbing a slope, the travel motor speed automatically shifts down into first gear. This increases the tractive effort and the travel motor will automatically switch back into fast gear once the load is reduced.



Selector valve for single or double acting pipe

The double acting pipe located on front of the fuel tank assures easy access and control. Lever direction: vertical = single acting piping (breaker); horizontal = double acting piping (clamshell)

Air cleaner

The easy-to-change plastic air cleaner allows faster, more convenient servicing and maintenance.

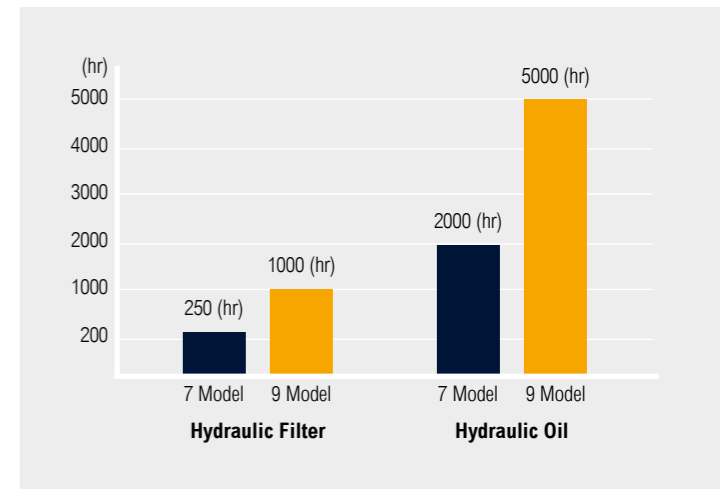

Long-life components

The R35Z-9A is enhanced with a number of components that extend service intervals, minimise operating costs and reduce machine downtime. These include bushings designed for extended lube intervals (250 hours), polymer shims for enhanced wear resistance and reduced noise, extended-life hydraulic filters (1000 hours), long-life hydraulic oil (5000 hours), more efficient cooling systems and integrated preheating systems.

Centralised grease points

Grease fittings are centralised in one lubrication bank for quick, easy servicing.



Parts & Warranties

HYUNDAI GENUINE PARTS AND WARRANTIES: THE BEST WAY TO PROTECT YOUR INVESTMENT

Hyundai Genuine parts, accessories and warranty programmes are specially designed to keep your machine covered. They increase uptime and maintain the performance, comfort and convenience that are built into your equipment.



A network you can rely on

Hyundai Construction Equipment Europe prioritises quick, reliable intervention to keep your equipment running reliably. In the 13000 m² warehouse, Hyundai covers over 96% of all Genuine Parts. With one of Europe's most advanced automated warehousing systems, we are able to maintain availability and efficient delivery of all our Genuine Parts. Moreover, we guarantee a 24-hour delivery service across our European dealer network.



Fuel filters

Hyundai fuel filters provide the right degree of filtration to keep your engine clean. They are designed to meet and exceed the engine manufacturer's prerequisites for water separation and dirt filtration, prolonging the life of your engine.



Hyundai Genuine parts

Hyundai Genuine parts have the same design as those installed when your machine left the factory. They are subjected to rigorous quality inspections and tests to make sure they meet Hyundai's strict requirements for quality and durability. As well as minimising downtime, this helps to ensure peak performance on every task.



Undercarriage parts

Hyundai track components deliver exceptional ride performance. The materials used comply with stringent quality control measures to ensure the highest reliability.

Hyundai warranties

Our warranties are designed to give you the cover you need to build your business with confidence and peace of mind.

Standard warranties

We offer standard warranty coverage for all compact excavators. In addition to this standard coverage, optional and extended warranty periods are available, so you can benefit from full warranty coverage for longer, and even over the full lifetime of your machines. Please discuss the optimal solution for your needs with your local Hyundai dealer.

Extended warranties

Our extended warranties help you maintain full control over your operating costs. If you combine an extended warranty programme with a tailored maintenance contract, you can completely avoid unexpected costs.

SPECIFICATIONS

ENGINE			
Maker / Model		Yanmar / 3TNV88-BSHYB	
Type		Water cooled, 4 cycle Diesel, 3-cylinders in line, direct injection, low noise	
Rated flywheel horse power	SAE	J1995 (gross)	18.2 kW (24.4 HP) / 2200 rpm
		J1349 (net)	17.7 kW (23.7 HP) / 2200 rpm
	DIN	6271/1 (gross)	18.2 kW (24.7 PS) / 2200 rpm
		6271/1 (net)	17.7 kW (24 PS) / 2200 rpm
Max. torque		9.1 kgf.m at 1320 rpm	
Bore x Stroke		88 mm x 90 mm	
Piston displacement		1642 cc	
Batteries		12V - 80AH	
Starting motor		12V - 2.3kW	
Alternator		12V - 55A	

HYDRAULIC SYSTEM	
MAIN PUMP	
Type	Variable displacement piston pumps
Max. flow	2 x 37.4 + 23.1 + 9.9 L/min
Sub-pump for pilot circuit	Gear pump

Cross-sensing and fuel saving pump system.

HYDRAULIC MOTORS	
Travel	Two speed axial piston motor with counter balance valve and parking brake
Swing	Axial piston motor with automatic brake

RELIEF VALVE SETTING	
Implement circuits	230 kgf/cm ² (3,270 psi)
Travel circuits	230 kgf/cm ² (3,270 psi)
Swing circuit	200 kgf/cm ² (2,840 psi)
Pilot circuit	30 kgf/cm ² (430 psi)
Service valve	Installed

HYDRAULIC CYLINDERS	
No. of cylinder bore x stroke	Boom: 85 x 540 mm
	Arm: 80 x 585 mm
	Bucket: 70 X 510 mm
	Boom swing: 80 X 400 mm
	Dozer blade: 95 X 152 mm

* Hyundai Bio Hydraulic Oil (HBHO) available

NOISE LEVEL (CABIN)	
Noise Levels (dynamic value)	
Exterior Sound Power Level (ISO 6395:2008)	94 dB(A)
Operator Sound Pressure Level (ISO 6396:2008)	75 dB(A)

COOLANT & LUBRICANT CAPACITY	
Refilling	litre
Fuel tank	40
Engine coolant	5.5
Engine oil	6.7
Hydraulic tank	37

TRAVEL LEVERS
Traveling and steering: two levers with pedals.

CONTROL	
Type	
Pilot control	Two joysticks with one safety lever (LH): Swing and arm, (RH): Boom and bucket with horn (ISO)
Engine throttle	Electronical, Accel dial type

SWING SYSTEM	
Swing motor	Axial piston motor
Swing reduction	Planetary gear reduction
Swing bearing lubrication	Grease-bathed
Swing brake	Wet disc
Swing speed	9.5 rpm

DIGGING FORCE (ISO)		
Bucket	1.3 m arm	1.6 m arm
	3130 kgf	3150 kgf
Arm	30.7 kN	30.9 kN
	1990 kgf	1720 kgf
	19.5 kN	16.9 kN

OPERATING WEIGHT (APPROXIMATE)			
Operating weight, including 2500 mm boom, 1300 mm arm, SAE heaped 0.11 m ³ excavator bucket, lubricant, coolant, full fuel tank, hydraulic tank and the standard equipment.			
Operating Weight		Rubber 300 mm	Steel 300 mm
	Cabin	3690 kg	3790 kg
	Canopy	3550 kg	3650 kg
Ground Pressure	Cabin	0.34 kg/cm ² (4.83 psi)	0.35 kg/cm ² (4.98 psi)
	Canopy	0.33 kg/cm ² (4.69 psi)	0.33 kg/cm ² (4.69 psi)

UNDERCARRIAGE	
X-leg type center frame is integrally welded with reinforced box-section track frames. The undercarriage includes lubricated rollers, track adjusters with shock absorbing springs and sprockets, and rubber shoes.	
Center frame	X - leg type
Track frame	Pentagonal box type
No. of carrier rollers on each side	1
No. of track rollers on each side	4

AIR CONDITIONING SYSTEM	
The air conditioning system contains fluorinated greenhouse gas refrigerant R134a (Global Warming Potential = 1430). The system contains 0.60 kg of refrigerant representing a CO ₂ equivalent of 0.86 metric tonnes.	

DIMENSIONS & WORKING RANGE

R35Z-9A DIMENSIONS

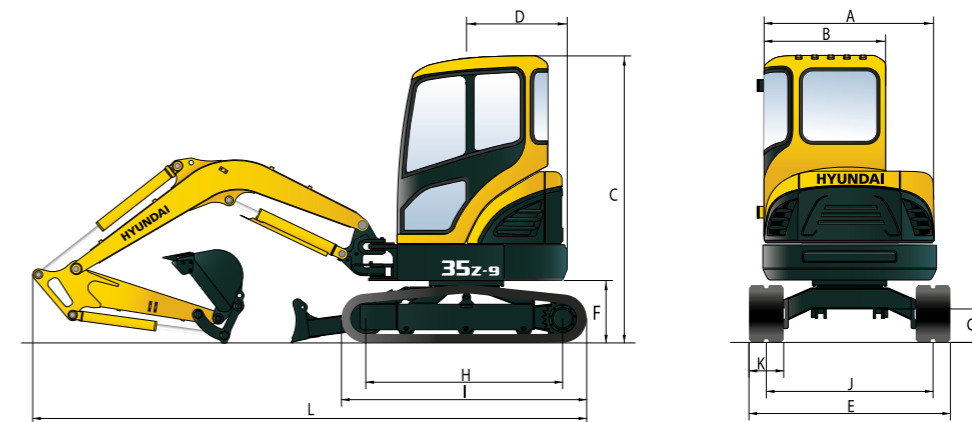

A	Overall width of upper structure	1500
B	Overall width of cab	1050
C	Overall height of cab	2500
D	Tail swing radius	870
E	Overall width	1740
F	Clearance under counterweight	540
G	Ground clearance	290
H	Tumbler distance	1700

Unit: mm

I	Track length	2130	
J	Track gauge	1440	
K	Track shoe width	300	
L	Overall length	1300 arm	4790
		1600 arm	4815

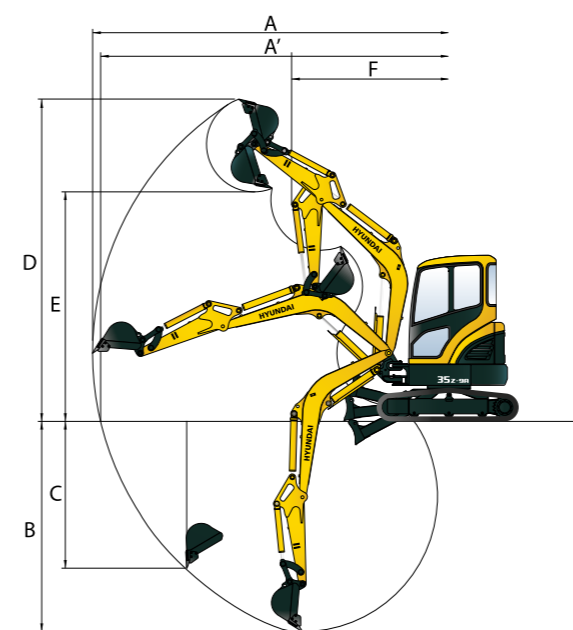

R35Z-9A WORKING RANGE



Unit: mm











	Boom length	2500	
	Arm length	1300	1600
A	Max. digging reach	5315	5605
A'	Max. digging reach at ground	5200	5495
B	Max. digging depth	3135	3440
C	Max. vertical wall digging depth	2190	2565
D	Max. digging height	4810	5010
E	Max. dumping height	3425	3615
F	Min. swing radius	2350	2330

LIFTING CAPACITY











 Rating over-front  Rating over-side or 360 degrees

R35Z-9A

Boom : 2.50 m / Arm : 1.30 m / w/o bucket / Dozer down : 300 mm Rubber track, Canopy w/o additional counterweight

Lift-point height m	Lift-point radius								At max. Reach		
	1.0 m		2.0 m		3.0 m		4.0 m		Capacity		Reach
											m
4.0 m	kg								*670	*670	3.12
3.5 m	kg								*640	580	3.66
3.0 m	kg						*630	500	*630	490	4.04
2.5 m	kg				*670	*670	*620	500	*630	440	4.30
2.0 m	kg				*790	780	*650	490	*630	410	4.48
1.5 m	kg				*930	750	*700	480	*640	390	4.58
1.0 m	kg				*1070	720	*740	470	*650	380	4.61
0.5 m	kg				*1160	700	*780	460	*660	380	4.57
0.0 m	kg		*1260	*1260	*1200	690	*790	460	*670	390	4.46
-0.5 m	kg		*1930	1320	*1180	690	*780	460	*690	420	4.27
-1.0 m	kg		*1900	1330	*1120	690			*690	460	4.00
-1.5 m	kg		*1640	1340	*980	700			*690	540	3.61
-2.0 m	kg		*1220	*1220	*680	*680			*660	*660	3.03

Boom : 2.50 m / Arm : 1.30 m / w/o bucket / Dozer up : 300 mm Rubber track, Canopy w/o additional counterweight

Lift-point height m	Lift-point radius								At max. Reach		
	1.0 m		2.0 m		3.0 m		4.0 m		Capacity		Reach
											m
4.0 m	kg								*670	*670	3.12
3.5 m	kg								620	540	3.66
3.0 m	kg						530	470	520	460	4.04
2.5 m	kg				*670	*670	530	470	470	410	4.30
2.0 m	kg				*790	720	520	460	430	380	4.48
1.5 m	kg				800	690	510	450	410	360	4.58
1.0 m	kg				770	670	500	440	410	350	4.61
0.5 m	kg				750	650	490	430	410	350	4.57
0.0 m	kg		*1260	1190	740	630	490	420	420	360	4.46
-0.5 m	kg		1450	1200	740	630	490	420	440	390	4.27
-1.0 m	kg		1460	1210	740	630			490	430	4.00
-1.5 m	kg		1480	1220	750	640			580	500	3.61
-2.0 m	kg		*1220	*1220	*680	660			*660	660	3.03











- Lifting capacity is based on SAE J1097, ISO 10567.
- Lifting capacity of the Robex Series does not exceed 75% of the tipping load with the machine on firm, level ground or 87% of full hydraulic capacity.
- The Lift-point is a hook located (standard equipment) on the back of the bucket.
- (*) indicates load limited by hydraulic capacity.
- Caution: please be aware of the local regulations and instructions for lifting operations.

LIFTING CAPACITY











 Rating over-front  Rating over-side or 360 degrees

R35Z-9A

Boom : 2.50 m / Arm : 1.60 m / w/o bucket / Dozer down: 300 mm Rubber tracks, Cabin w/o additional counterweight

Lift-point height m	Lift-point radius								At max. Reach				
	1.0 m		2.0 m		3.0 m		4.0 m		Capacity		Reach		
											m		
4.0 m	kg									*580	*580	3.57	
3.0 m	kg							*540	*540	*550	460	4.37	
2.0 m	kg						*680	*680	*590	530	*530	400	4.77
1.0 m	kg						*980	780	*700	510	*550	370	4.89
0.0 m	kg			*1320	*1320	*1170	730	*780	490	*620	380	4.76	
-1.0 m	kg	*1570	*1570	*2070	1380	*1150	720	*750	480	*640	430	4.34	
-2.0 m	kg	*2520	*2520	*1520	1420	*880	740			*640	600	3.50	

Boom : 2.50 m / Arm : 1.60 m / w/o bucket / Dozer up: 300 mm Rubber tracks, Cabin w/o additional counterweight

Lift-point height m	Lift-point radius								At max. Reach				
	1.0 m		2.0 m		3.0 m		4.0 m		Capacity		Reach		
											m		
4.0 m	kg									*580	*580	3.57	
3.0 m	kg							*540	510	490	430	4.37	
2.0 m	kg						*680	*680	560	490	420	370	4.77
1.0 m	kg						830	720	540	470	390	340	4.89
0.0 m	kg			*1320	1250	790	670	520	450	410	350	4.76	
-1.0 m	kg	*1570	*1570	1530	1260	780	660	510	440	460	400	4.34	
-2.0 m	kg	*2520	*2520	*1520	1290	800	680			*640	550	3.50	











- Lifting capacity is based on SAE J1097, ISO 10567.
- Lifting capacity of the Robex Series does not exceed 75% of the tipping load with the machine on firm, level ground or 87% of full hydraulic capacity.
- The Lift-point is a hook located (standard equipment) on the back of the bucket.
- (*) indicates load limited by hydraulic capacity.
- Caution: please be aware of the local regulations and instructions for lifting operations.

LIFTING CAPACITY











 Rating over-front  Rating over-side or 360 degrees

R35Z-9A









Boom : 2.50 m / Arm : 1.60 m / w/o bucket / Dozer down: 300 mm Rubber tracks, Cabin with additional counterweight









Lift-point height m	Lift-point radius										
	1.0 m		1.5 m		2.0 m		2.5 m		3.0 m		
											
4.0 m	kg										
3.5 m	kg										
3.0 m	kg										
2.5 m	kg										
2.0 m	kg								*680	*680	
1.5 m	kg						*1050	*1050	*830	*830	
1.0 m	kg						*1320	1130	*980	860	
0.5 m	kg						*1500	1090	*1100	830	
0.0 m	kg					*1320	*1320	*1570	1070	*1170	820
-0.5 m	kg	*1180	*1180	*1280	*1280	*1770	1530	*1560	1060	*1180	810
-1.0 m	kg	*1570	*1570	*1760	*1760	*2070	1540	*1500	1060	*1150	810
-1.5 m	kg	*2000	*2000	*2320	*2320	*1850	1550	*1360	1070	*1060	810
-2.0 m	kg	*2520	*2520	*2300	*2300	*1520	*1520	*1140	1090	*880	830

Boom : 2.50 m / Arm : 1.60 m / w/o bucket / Dozer up: 300 mm Rubber tracks, Cabin with additional counterweight

Lift-point height m	Lift-point radius										
	1.0 m		1.5 m		2.0 m		2.5 m		3.0 m		
											
4.0 m	kg										
3.5 m	kg										
3.0 m	kg										
2.5 m	kg										
2.0 m	kg								*680	*680	
1.5 m	kg						*1050	*1050	*830	*830	
1.0 m	kg						1220	1040	930	800	
0.5 m	kg						1180	1000	900	770	
0.0 m	kg					*1320	*1320	1160	980	880	760
-0.5 m	kg	*1180	*1180	*1280	*1280	1690	1400	1150	980	870	750
-1.0 m	kg	*1570	*1570	*1760	*1760	1700	1400	1160	980	870	750
-1.5 m	kg	*2000	*2000	*2320	*2320	1720	1420	1170	990	880	750
-2.0 m	kg	*2520	*2520	*2300	*2300	*1520	1440	*1140	1000	*880	770

- Lifting capacity is based on SAE J1097, ISO 10567.
- Lifting capacity of the Robex Series does not exceed 75% of the tipping load with the machine on firm, level ground or 87% of full hydraulic capacity.
- The Lift-point is a hook located (standard equipment) on the back of the bucket.
- (*) indicates load limited by hydraulic capacity.
- Caution: please be aware of the local regulations and instructions for lifting operations.

Lift-point radius						At max. Reach		
3.5 m		4.0 m		4.5 m		Capacity		Reach
								m
*570	*570					*580	*580	3.57
*510	*510	*560	*560			*570	*570	4.04
*520	*520	*540	*540			*550	520	4.37
*560	*560	*550	*550	*560	490	*530	470	4.61
*630	*630	*590	590	*570	490	*530	440	4.77
*710	710	*640	580	*600	480	*530	430	4.87
*800	690	*700	570	*630	470	*550	420	4.89
*880	670	*740	550	*660	470	*580	420	4.86
*930	660	*780	550	*670	460	*620	430	4.76
*950	650	*780	540	*650	460	*630	450	4.59
*920	650	*750	540			*640	490	4.34
*840	650					*650	550	3.99
*640	*640					*640	*640	3.50

Lift-point radius						At max. Reach		
3.5 m		4.0 m		4.5 m		Capacity		Reach
								m
*570	*570					*580	*580	3.57
*510	*510	*560	560			*570	550	4.04
*520	*520	*540	*540			*550	480	4.37
*560	*560	*550	*550	520	460	500	440	4.61
*630	*630	*590	550	520	460	470	410	4.77
*710	660	620	540	510	450	450	400	4.87
730	640	600	530	500	440	440	390	4.89
720	620	590	510	500	430	440	390	4.86
700	610	580	510	490	430	460	400	4.76
700	600	580	500	490	430	480	420	4.59
700	600	580	500			520	450	4.34
700	610					590	510	3.99
*640	620					*640	620	3.50



Specifications and design are subject to change without notice. Pictures of Hyundai Construction Equipment Europe products may show other than standard equipment.

Hyundai Construction Equipment Europe nv,
Hyundailaan 4, 3980 Tessenderlo, Belgium.
Tel: (+32) 14-56-2200 Fax: (+32) 14-59-3405

EN - 2021.11 Rev 0

Ready to experience the Hyundai Effect?

Contact your Hyundai dealer.
hyundai-ce.eu/en/dealer-locator

